

REGISTRI TELAIO, ANGOLI FERMAVETRO, ACCESSORI VARI
LEVELLING MECHANISMS, CORNER PIECES FOR ROUNDED
AND ACCESSORIES
EXPANSEURS, ANGLES PAR CLOSE ET ACCESSOIRES
EXPANSORES, ESQUINEROS JUNQUILLO REDONDO
Y ACCESORIOS

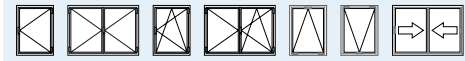

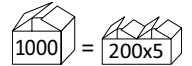

art. 0136

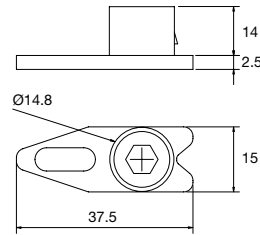

ITA	EN	FR	ES
Espansore metallico per camera da 10 mm con grano da 15mm. Per compensare la tolleranza tra il telaio a camera chiusa in alluminio e controtelaio.	Levelling mechanism for 10 mm groove profiles. For adjusting the gap between the aluminium closed groove profile and subframe. Supplied with 15 mm grub screw.	Expanseur métallique pour canal de 10 mm avec grain de 15 mm. Pour compenser le jeu entre le cadre fermé en aluminium et le précadre.	Expansor metálico para cámara de 10 mm con grano de 15 mm. Que compensa la tolerancia entre el perfil en aluminium y el premarco de hierro.

art. 0138

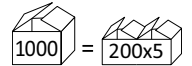
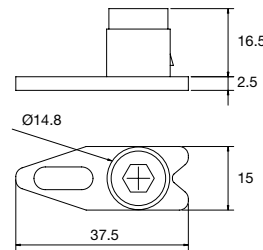

ITA	EN	FR	ES
Espansore metallico per camera da 14 mm con grano da 15mm.	Levelling mechanism for 14 mm groove profiles.	Expanseur métallique pour canal de 14 mm avec grain de 15 mm.	Expansor metálico para cámara de 14 mm con grano de 15 mm.

piastrina in zama

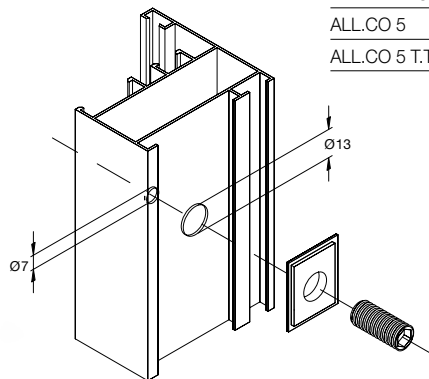

art. 0141

PROFILI - PROFILES - PROFILÉS - PERFILES

ABITHAL POINT	ALL.CO P4	ERRE 50 T.T.
ALL.CO 5	ALPHA 445	ERRE 60 T.T.
ALL.CO 5 T.T.	ALPHA 545	NUOVO NC 40
	ALPHA 560	NUOVO NC 50
	ALPHA GLOBO	OVERLAY
	EKIP 40	SISTEMA UNO
	EKIP THERMO 53	PARIGI
	ERRE 35	PE 60 SLIDE
	ERRE 40	PE 70 T.T. SLIDE
	ERRE 50	SKEIT 45
	ERRE 50/S	SKEIT 90

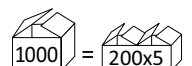

ITA	EN	FR	ES
Piastrina in zama pressofusa per compensare la tolleranza tra il telaio a camera chiusa in alluminio e controtelaio. Da abbinare ai grani in alluminio estruso.	Plate made from die-cast zamak for adjusting the gap between the aluminium closed groove and the subframe. To be used with extruded aluminium grubsscrew.	Plaque en zamak moulé sous pressofusion pour compenser la tolérance entre le profilé à connelure fermée de l'aluminium et du précadre en fer. A lier ensemble aux grains en aluminium extrudé.	Placa en zamak compensa la tolerancia entre el perfil y el premarco de hierro. De fijación con allen.

grani in alluminio estruso

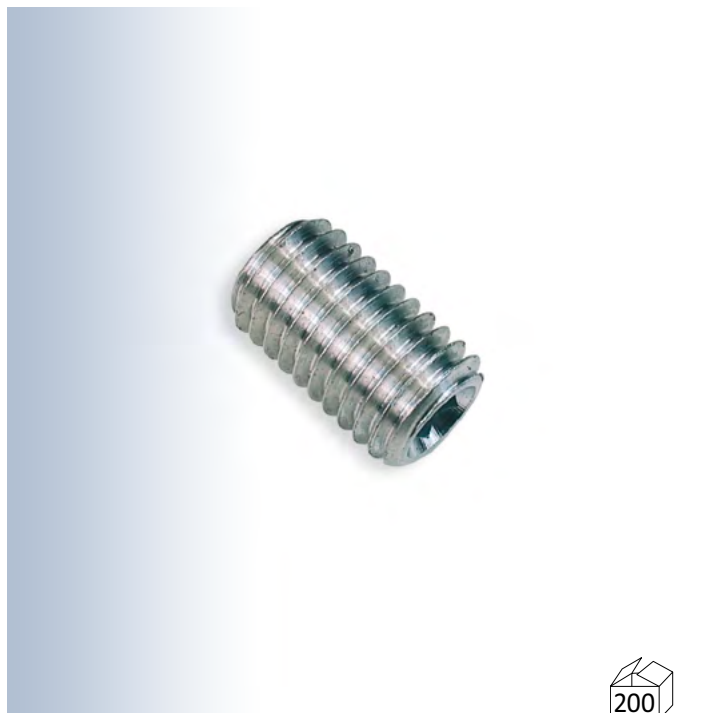
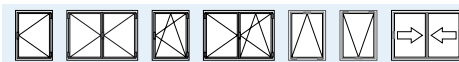

art. 0143	mm. 15
art. 0143.1	mm. 12
art. 0144	mm. 17
art. 0145	mm. 20
art. 0146	mm. 30
art. 0147	mm. 45
art. 0148	mm. 60

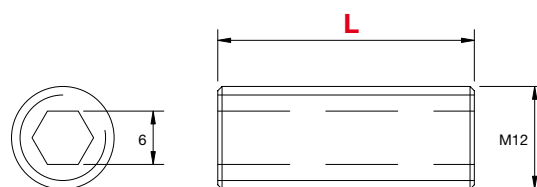

ITA	EN	FR	ES
Grano M12 in alluminio estruso	Extruded aluminium M12 grub screw	Grain M12 en aluminium extrudé	Allen M12 de aluminio extruido

viti per 3ª chiusura

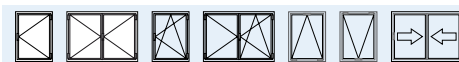

art. 0051.1	mm. 19.5	
art. 0051.2	mm. 25.5	
art. 0052.1	mm. 22.5	
art. 0053.1	mm. 30	
art. 0053.2	mm. 35	
art. 0053.3	mm. 32.5	

ITA	EN	FR	ES
Vite per 3ª chiusura	Screw for 3rd lock	Vis for 3ª fermeture	Bulon de conexion a/ exterior